

esybox MAX

LINE UP TO THE FUTURE

ELECTRONIC BOOSTER SETS

.....



CARING FOR THE FUTURE

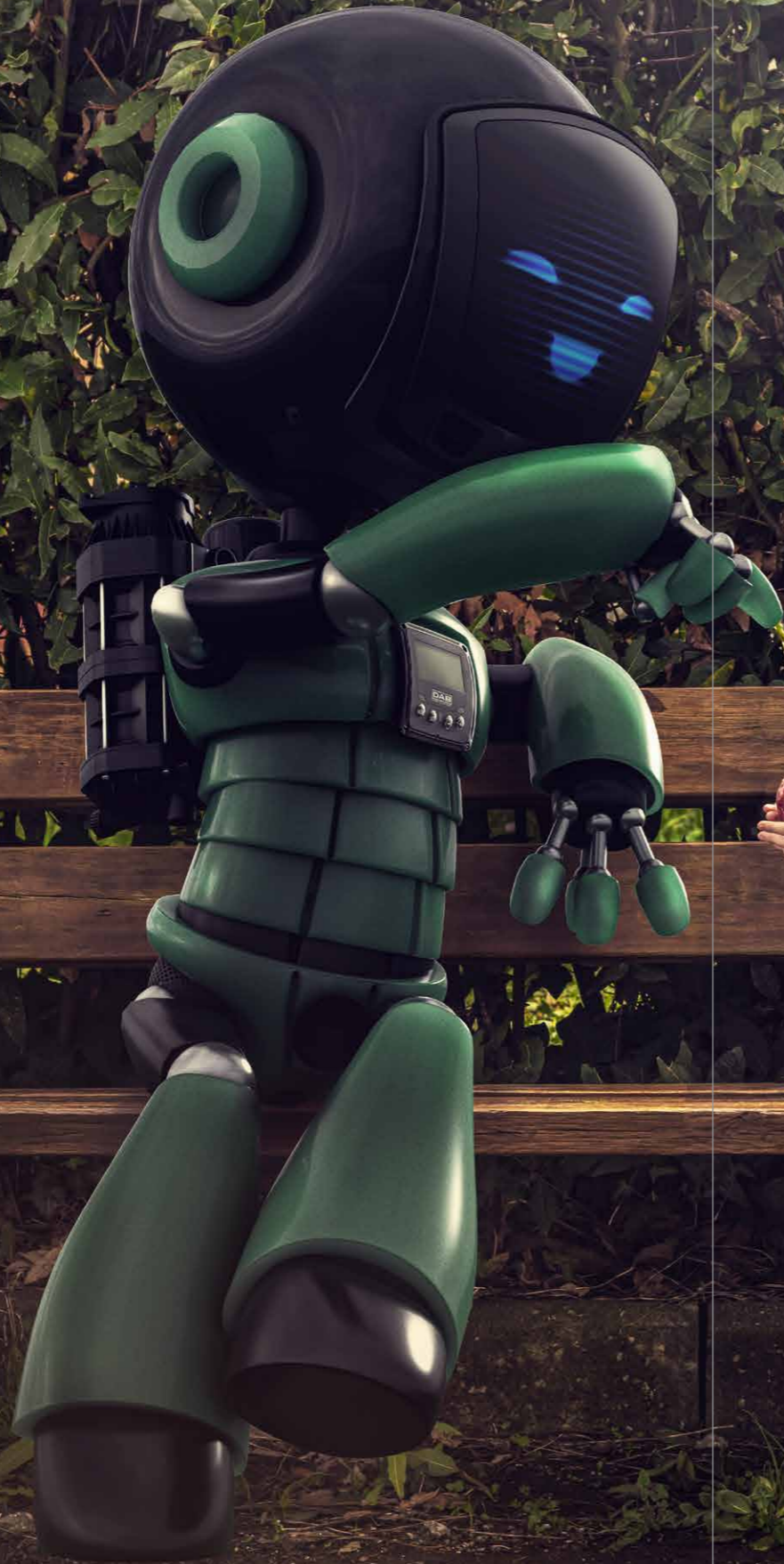

IT'S NOT JUST A MATTER OF TALKING ABOUT PERFORMANCE OR TECHNICAL FEATURES, OR EVEN STATING THAT WE ARE BETTER THAN THE COMPETITION.

WE REALLY NEED TO START FROM PEOPLE; FROM USERS. AND IF WE GIVE THEM SOMETHING THAT CAN SIMPLIFY OR IMPROVE THEIR LIVES, THEN THEY WILL BE HAPPY TO FOLLOW US.

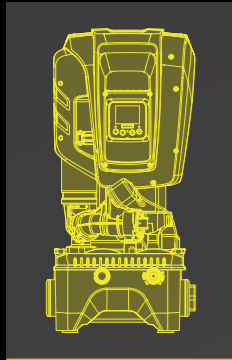

APARTMENTS

Example: 10 floors
20 apartments

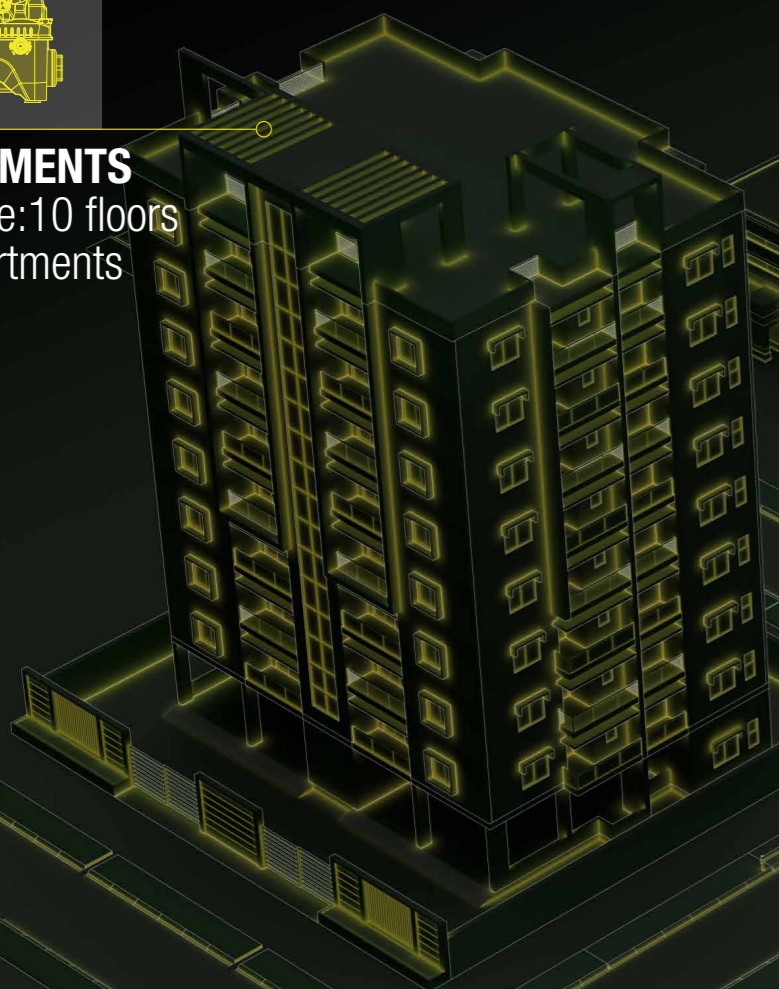

HOTEL

Example: 6 floors
80 rooms

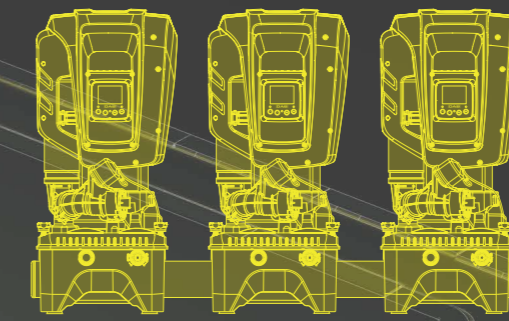
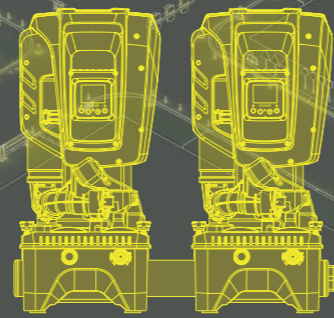

HOSPITAL

Example: 4 floors
100 beds

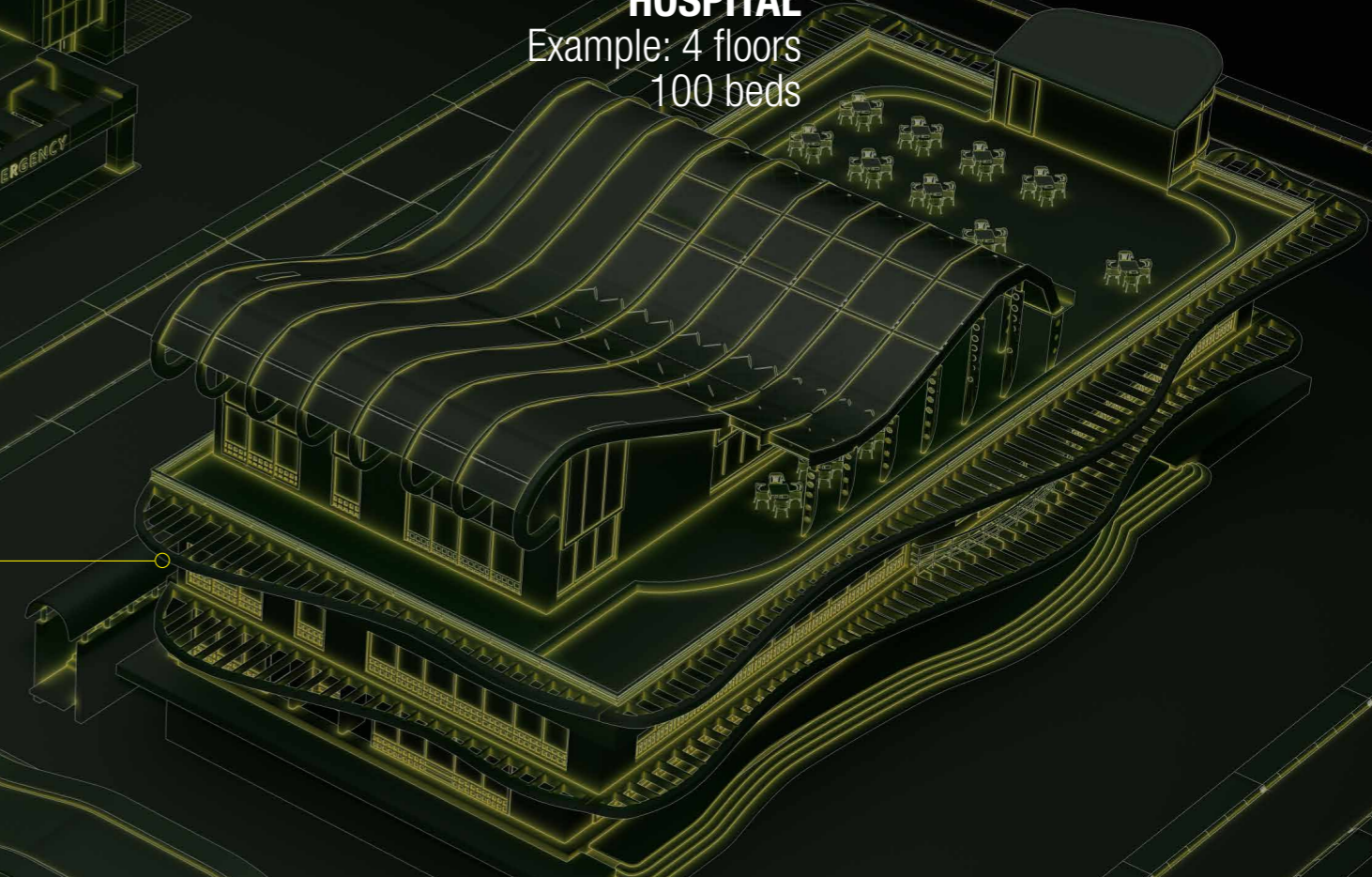

The building type/*Esybox Max* number combinations proposed here are simply examples. Product configurations can be modulated in different ways according to the specifications of each project.

It is not just a great pump

It's a new concept, breaking into the booster set industry.



esybox max

The Product Journey

“Once you identify the right audience and their problems, your products come next”



Paolo Montanari
Group Marketing and Sales Director

THE VISION

“When we started to think about Esybox Max we asked ourselves how to manage the evolution of the Esybox Line.

It was clear from the very beginning, it could not be just something bigger.

We felt we had to bring forward the path of evolution completely changing the rules of the game for booster sets in residential & commercial buildings.

Esybox Max is the outcome of listening and communicating with many different people who will be in direct contact with the product”



ENGINEER

“Choosing a product with the right performance for my projects often takes too much time. I need a solution with maximum energy efficiency and with reduced dimensions compared to traditional ones.”



WHOLESALER

“I need to improve the efficiency of my warehouse in order to always guarantee product availability to my customers.”



INSTALLER

“I need easy-to-install products that save me time, as I often find that the plant rooms are narrow with difficult access!”



MAINTAINER

“There is a lot of talk about IoT, how can I offer a better service to my customers and introduce a new model for my business using the *Internet of Pumps*?”



END USER

“The costs on the bill are always higher, I need reliable solutions for my system that help me to reduce my energy consumption.”



ENVIRONMENT

“It is crucial to understand that taking care of yourself also means taking care of the environment. By the truth, too much words are not needed, but rather simple facts.”



ENGINEER

Easy Selection

Understanding a new range has never been easier. Now you only need to select from two different hydraulic models depending on the height of the building. Then you can create your booster set, with up to four pumps, depending on the demand.

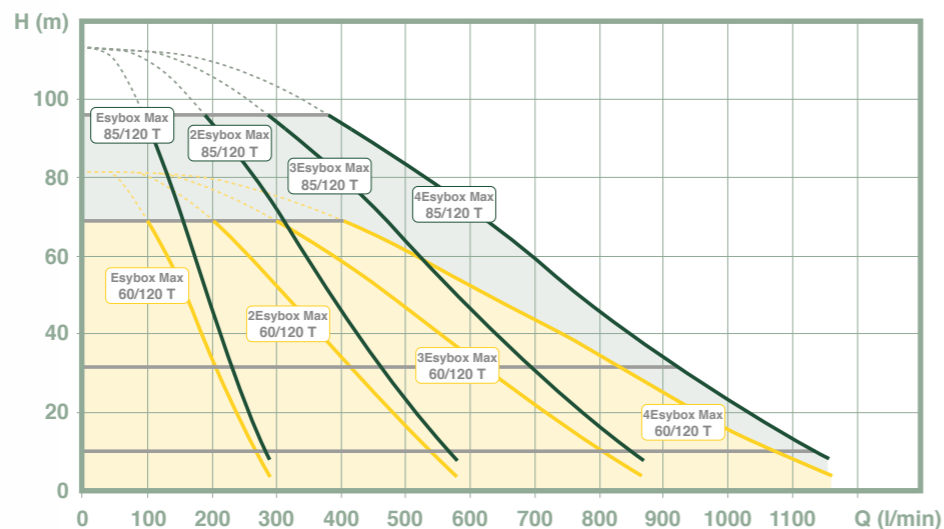

Efficiency at the state of the art

The DAB inverter has been combined with a brand new permanent magnet motor. We also designed completely new hydraulics, making it leap ahead in terms of energy efficiency.

BEFORE

AFTER

20%

Energy Saving

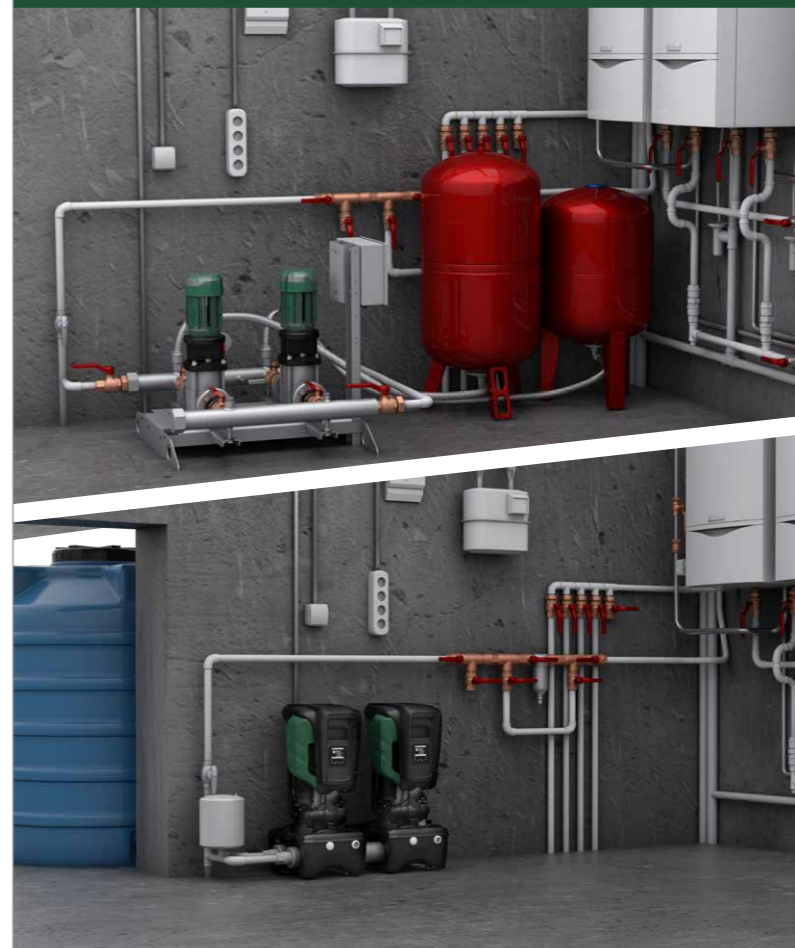
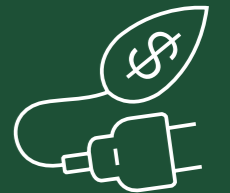

Modular Integration

Esybox Max is the most compact and integrated booster set available on the market compared with any traditional solution.

DCONNECT

Affordable web based remote control for your projects

Based on state-of-the-art technology, **DConnect built-in** offers many more advantages than typical BMS systems.

Performance data storage and remote monitoring support you to control, from anywhere, that the running parameters of the pumps follow exactly to your project specification avoiding any possible site issues for complete peace of mind.



What about logistics

Esybox Max will improve the storage efficiency in your warehouse.

Where there was once 1 booster, now there are 3 of them: that's three times more efficient!

This allows you to store the full range on one pallet: your customers will appreciate it because you can always guarantee them the availability of the solutions they need.

That's efficiency!



WHOLESALER



One traditional booster sets with two pumps



Six Esybox Max + three 2 Esydock Max

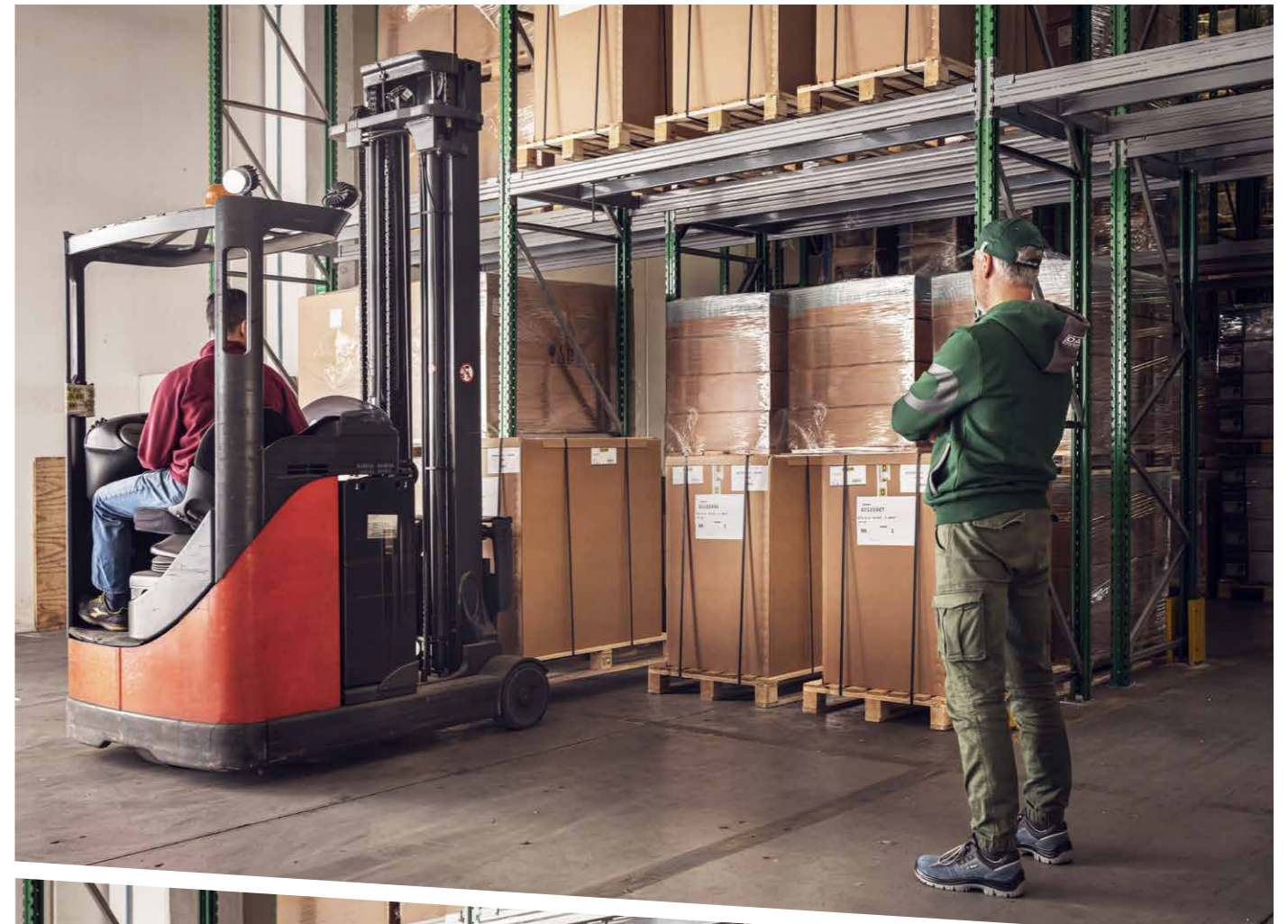



Easy to move & install

Keeping it flexible, we have the On-Site Assembly concept. So if you have difficulties getting to the pumps location, due to narrow stairways and corridors etc, you can choose to assemble your booster on-site which will only require moving smaller lighter boxes into the location, by means of practical handles.



INSTALLER

As quick as a “click”

Install Esysdock into your pipework system and simply “plug” your pumps in. A final quick set up via the digital DConnect app completes your installation project.



D+CONNECT

Affordable web based remote control for your installation

You can use your smartphone to connect directly with the pump using the simple interface. It will automatically detect the language, time and unit of measurement at the installation site, which will save you time during the first set up of the system. All adjustments are possible remotely allowing total control with no unwanted surprises. DConnect makes monitoring DAB products easy and intuitive.



Easy to maintain

Why waste your time stuck in a traffic jam getting to your customers pumps?

Now you can connect to them from anywhere.

From the coffee shop, car or the comfort of your own home, just log on through your PC or smartphone to the DConnect app. All you need to do is check the stored data and change any setting with just one click.

MAINTAINER

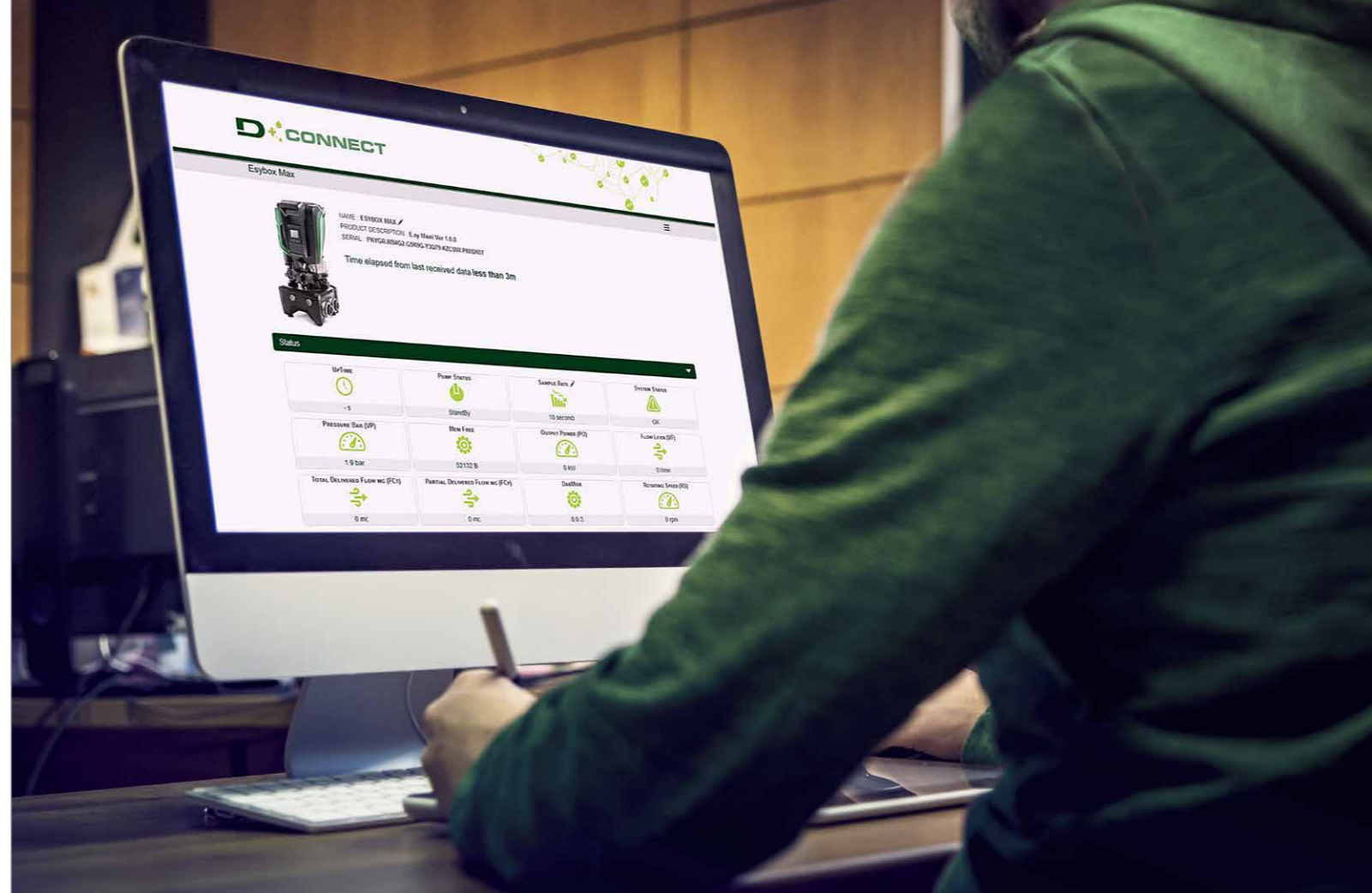

D+CONNECT

A new boost for your business

Thanks to 'Internet of Pumps' technology, you will be able to monitor and control your installations receiving alarms and notifications on any possible malfunctions or issues and keeping the main operating data under control, such as energy and water consumption.

You'll experience a reduction in costs associated with on-site visits and duration of interventions, guaranteeing at the same time greater reliability of the systems.

With DConnect you can offer your customers a more effective and economical service, such as the new *Silver* and *Gold* packages, these allow basic and advanced assistance and are linked to the set up of the Esybox Max, allowing continual monitoring and remote control of the systems, connecting you in real-time to receive specific and settable alarms or reports on the performance of the systems.



Here comes the COMFORT

Energy-saving, thanks to the integrated inverter it optimises performance; comfort, thanks to the DConnect app which allows you to manage the pressure required at any given moment to enjoy, for example, a nice warm boosted shower in total relaxation.

LESS COSTS ON YOUR BILL!

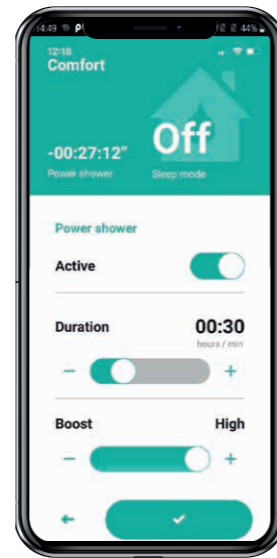

VISIT OUR WEBSITE
TO CALCULATE YOUR SAVING



END USER



ENVIRONMENT



Designed for the environment

“SUSTAINABILITY, for DAB, is not just technology, it's much more.”



The Esybox Max is state-of-the-art in the field of energy efficiency.



Constructed with recycled materials wherever possible.



Incredibly efficient in lowering CO₂ emissions during transportation.

Bare integration

With Eskybox Max the concept of integration has reached a new standard. Each new component is combined to deliver a better user experience of the product.



- 1 DISPLAY
- 2 VARIABLE FREQUENCY DRIVE
- 3 WIFI/BLUETOOTH MODULE
- 4 PRESSURE SENSOR (delivery side)
- 5 PRESSURE SENSOR (suction side)
- 6 NON-RETURN VALVE
- 7 2 LT. EXPANSION TANK
- 8 IMPELLERS
- 9 HYDRAULICS CONNECTIONS
- 10 FAST CONNECTION TOOL
- 11 WATER COOLED PERMANENT MAGNET MOTOR
- 12 HANDLES



The assembling technology

ERGONOMICS

Every single operator movement has been analysed and studied to create a production line that is as safe as efficient.



QUALITY

All assembly operations are performed with an equipment that's monitored by a centralized control system for which the operator has all the necessary instructions immediately available on the display. After each pre-assembly phase, the various components undergo control tests (*quality gates*) to ensure that they work perfectly. No component proceeds to the next assembly phase if it has not passed each test.



TRACEABILITY

The entire assembly process is optimized. All technical and historical data of the production process and of the product are recorded in a unique database that can be traced at any time. The data control and the traceability system is designed to take full advantage of the potential of our Manufacturing Execution System (MES).



For DAB, the research and application of new technologies mean finding the best possible solution to users' needs, while fully respecting the environment.

Technological innovation is never an end in itself but it's functional to perfecting the quality of work and maximising product reliability.

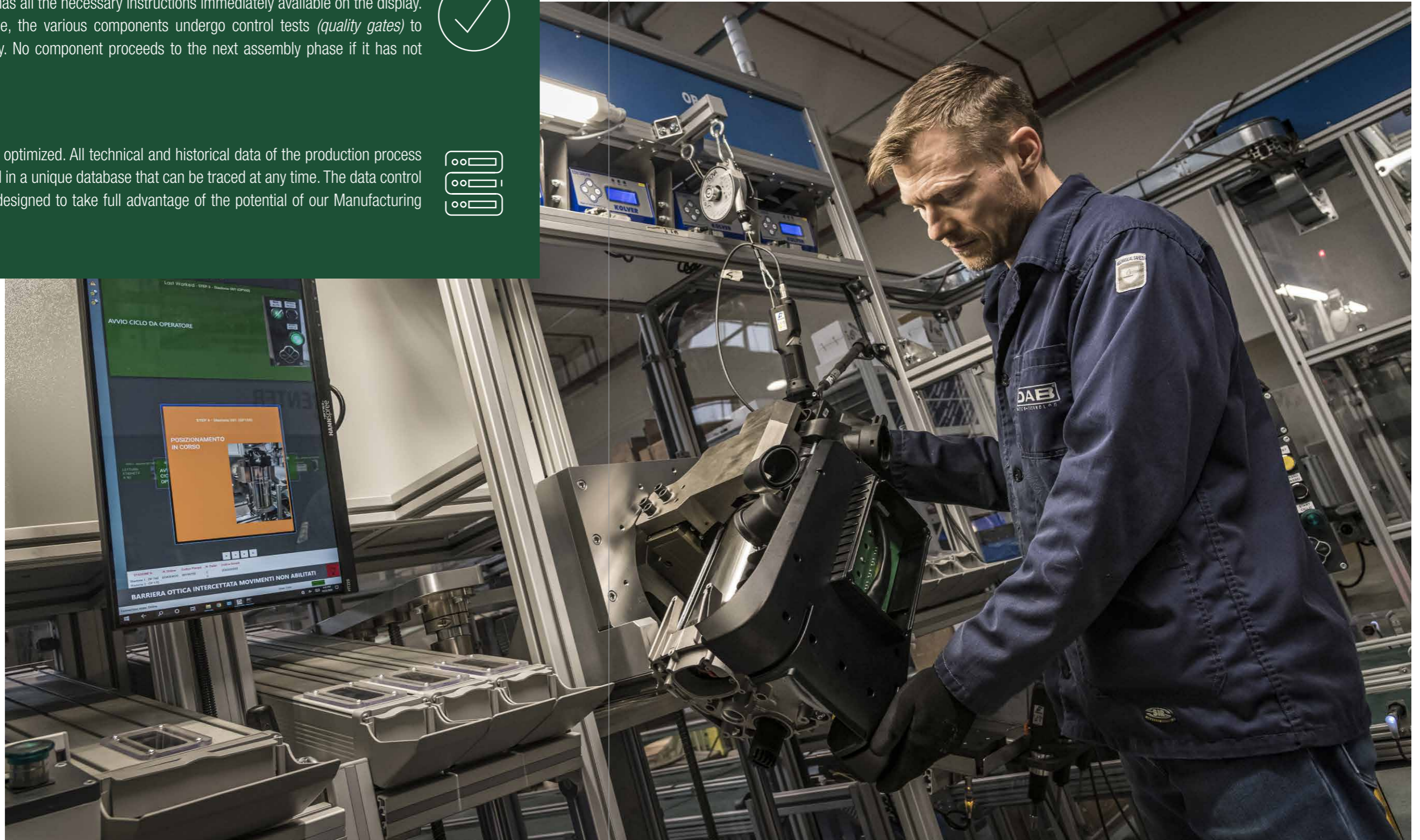

Thechnical Data

FLOW RATE:	Up to 17,4 m ³ /h (For single unit)
HEAD:	96 m
LIQUID TEMPERATURE:	+50°C
MAXIMUM AMBIENT TEMPERATURE:	+55°C
MAXIMUM INLET PRESSURE:	5 bar
OPERATION PRESSURE:	12 bar / 1200 kPa
MAXIMUM DIFFERENTIAL PRESSURE	9,4 bar (85/120); 6,7 bar (60/120)
CONSTANT PRESSURE RANGE:	1-12 bar (3 bar by default)
MOTOR PROTECTION CLASS:	IP X5
MOTOR INSULATION CLASS:	F
IMPELLER MATERIAL:	Technopolymer
SINGLE PHASE POWER INPUT:	208-240V 50/60Hz
THREE PHASE POWER INPUT:	380-480V 50/60Hz
TYPE OF INSTALLATION:	Fixed in vertical position
TYPE OF PUMPED LIQUID:	Clean, free from solid or abrasive substances, non-viscous, non-aggressive, non-crystallized and chemically neutral
CERTIFICATION:	WRAS, ACS, NSF61 (are pending approval)

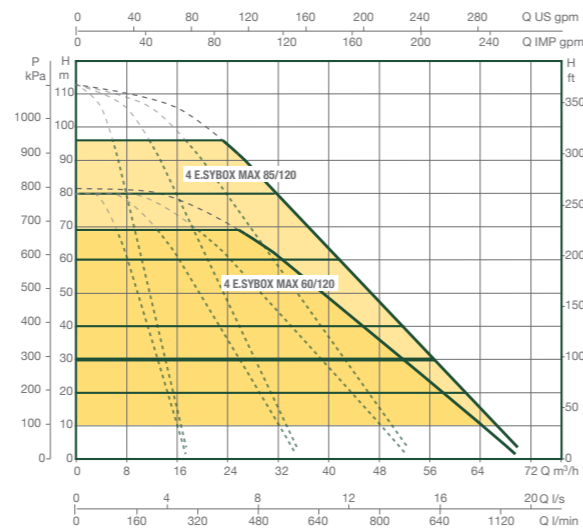
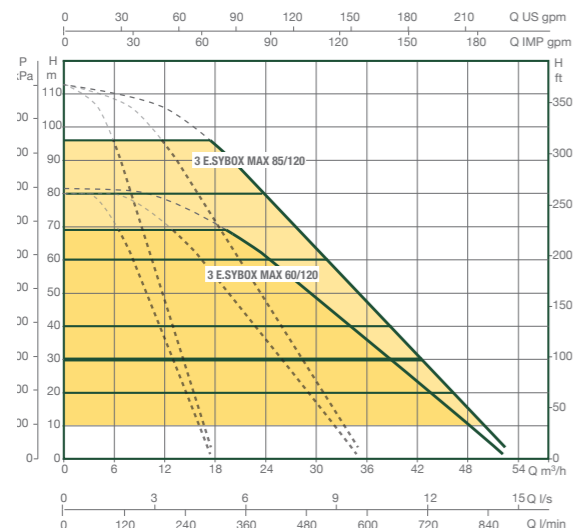
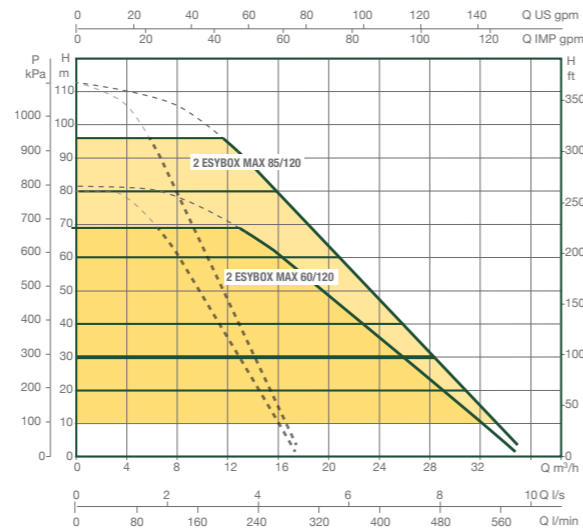
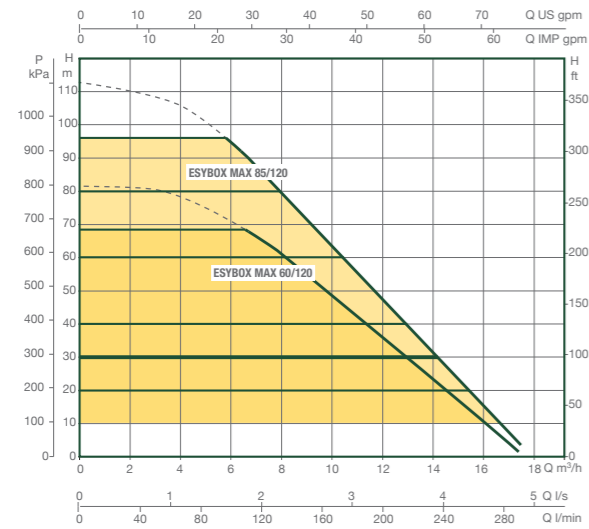

Accessories

ESY I/O

The electronic expansion module allows Esybox Max to interface with the external input/output devices (eg: float switch, pressure switch, remote alarm) and with the BMS world (Building Management System).



ESYBOX MAX	2 ESYBOX MAX	3 ESYBOX MAX	4 ESYBOX MAX
•	•	•	•



CONTROL PANEL

Electrical connection panels for 2 or 3 pumps, completed with magnetothermic switches for powering multi-pump units.

It can be installed on the wall or directly to Esybox Max units using the dedicated pillar kit.

DESCRIPTION	ESYBOX MAX	2 ESYBOX MAX	3 ESYBOX MAX	4 ESYBOX MAX
CONTROL PANEL E2G5.2	-	• Single phase	-	• 2 x Single phase
CONTROL PANEL E2G7	-	• three-phase	-	• 2 x three-phase
CONTROL PANEL E3G10.5	-	-	• three-phase	-

PILLAR KIT

Useful for mounting the control panel EG on board of the 2 or 3 Esydock Max.

ESYBOX MAX	2 ESYBOX MAX	3 ESYBOX MAX	4 ESYBOX MAX
-	•	•	2X



JOINT KIT

kit consisting of 2 pieces of 3-piece unions and 2 pieces of 2" nipples to connect the delivery and suction of a pair of 2 Esydock Max to create 4-unit Esybox Max groups.

ESYBOX MAX	2 ESYBOX MAX	3 ESYBOX MAX	4 ESYBOX MAX
-	-	-	•



**DAB PUMPS LTD.**

6 Gilberd Court
Newcomen Way
Severalls Business Park
Colchester
Essex
C04 9WN - UK
salesuk@dwtgroup.com
Tel. +44 0333 777 5010

**DAB PUMPS BV**

'tHofveld 6 C1
1702 Groot Bijgaarden - Belgium
info.belgium@dwtgroup.com
Tel. +32 2 4668353

**DAB PUMPS B.V.**

Albert Einsteinweg, 4
5151 DL Drunen - Nederland
info.netherlands@dwtgroup.com
Tel. +31 416 387280
Fax +31 416 387299

**DAB PUMPS GMBH**

Am Nordpark 3
D - 41069 Mönchengladbach - Germany
info.germany@dwtgroup.com
Tel. +49 2161 47388-0
Fax +49 2161 47388-36

**DAB PUMPS IBERICA S.L.**

Calle Verano 18-20-22
28850 - Torrejón de Ardoz - Madrid
Spain
Info.spain@dwtgroup.com
Tel. +34 91 6569545
Fax: + 34 91 6569676

**DAB PUMPS HUNGARY KFT.**

H-8800
Nagykanizsa, Buda Ernő u.5
Hungary
Tel. +36 93501700

**DAB PUMPS POLAND Sp. z o.o.**

Ul. Janka Muzykanta 60
02-188 Warszawa - Poland
polska@dabpumps.com.pl

**OOO DAB PUMPS**

Novgorodskaya str. 1, block G
office 308, 127247, Moscow - Russia
info.russia@dwtgroup.com
Tel. +7 495 122 0035
Fax +7 495 122 0036

**DAB PUMPS INC.**

3226 Benchmark Drive
Ladson, SC 29456 - USA
info.usa@dwtgroup.com
Tel. 1-843-797-5002
Fax 1-843-797-3366

**DAB PUMPS SOUTH AFRICA (PTY) LTD**

Twenty One industrial Estate,
16 Purlin Street, Unit B, Warehouse 4
Olifantsfontein -1666 - South Africa
info.sa@dwtgroup.com
Tel. +27 12 361 3997

**DAB PUMPS (QINGDAO) CO. LTD.**

No.40 Kaituo Road, Qingdao Economic & Technological
Development Zone
Qingdao City, Shandong Province - China
PC: 266500
sales.cn@dwtgroup.com
Tel. +86 400 186 8280
Fax +86 53286812210

**DAB PUMPS DE MÉXICO, S.A. DE C.V.**

Av Amsterdam 101 Local 4
Col. Hipódromo Condesa,
Del. Cuauhtémoc CP 06170
Ciudad de México
Tel. +52 55 6719 0493

**DAB PUMPS OCEANIA PTY LTD**

426 South Gippsland Hwy,
Dandenong South VIC 3175 - Australia
info.oceania@dwtgroup.com
Tel. +61 1300 373 677

**PT DAB PUMPS INDONESIA**

Satrio Tower lantai 26
unit C-D, Jl. Prof. Dr. Satrio Kav. C4,
Kel. Kuningan Timur, Kec. Setiabudi, Kota Adm.
Jakarta Selatan, Prov. DKI Jakarta. - Indonesia
Tel. +62 2129222850